

VIDEOLOGY

IMAGING SOLUTIONS INC.
Original Equipment Manufacturer

User Manual for LCD Monitors

45M10-1	10.4" TFT
45M15	15" TFT
45M17	17" TFT
45M20-1	20" TFT



Prior to Using This Document: Videology reserves the right to modify the information in this document as necessary and without notice. It is the user's responsibility to be certain they possess the most recent version of this document by going to www.videologyinc.com, searching for the model number, and comparing revision letters on the respective document, located in the document's footer.

For technical assistance with this product, please contact the supplier from whom the product was purchased.

Videology Imaging Solutions, Inc. USA
37M Lark Industrial Parkway
Greenville, RI 02828
Tel: 401-949-5332
Fax: 401-949-5276
www.videologyinc.com

Videology Imaging Solutions, B.V. Europe
Neutronenlaan 4
NL-5405 NH Uden, Netherlands
Tel: +31 (0) 413-256261
Fax: +31 (0) 413-251712
www.videology.nl

Table of Contents

- 1. Document History3
- 2. Warning3
- 3. Precautions.....3
 - 3.1. Safety3
 - 3.2. Installation.....4
 - 3.3. Cleaning4
- 4. Federal Communications Commission (FCC) Statement4
- 5. Features.....5
 - 5.1. 45M10-1 10.4" TFT5
 - 5.2. 45M15 15" TFT5
 - 5.3. 45M17 17" TFT5
 - 5.4. 45M20-1 20" TFT5
- 6. Operating Instructions6
 - 6.1. Control for 10", 15" and 20" LCDs.....6
 - 6.2. Control for 17" LCD.....7
- 7. Connectors8
 - 7.1. 10.4" Monitor Back Panel8
 - 7.2. 17" Monitor Back Panel.....9
 - 7.3. 15", 20" Monitor Back Panel10
- 8. OSD Architecture.....11
 - 8.1. Video Function 10", 15", 20"11
 - 8.2. Video Function (PC Mode Only) 10", 15", 20"12
 - 8.3. OSD Functions for 17" (45M17)13
 - 8.3.1. Source13
 - 8.3.2. Item (Hot key, simple operation)13
 - 8.3.3. OSD Menu.....13
 - 8.4. Audio Function (10", 15" 20").....18
- 9. LCD Monitor Mounting Guide.....19
 - 9.1. Desktop Mount19
 - 9.2. Wall / VESA mount.....19
- 10. Device Connectors.....20
- 11. Specifications22
- 12. Appendixes.....23
 - 12.1. Troubleshooting23
 - 12.2. Package Contents23
- 13. Remote Control.....24
 - 13.1. Remote Control For 10", 15", 20" LCDs24
 - 13.2. Remote Control for 17" LCD.....25
- 14. Contact Information26

1. Document History

Revision	Issue Date	Reason	CN#
Rev A	09-21-2007	Initial release	05-0688
Rev B	07-24-2006	Added 45M10-1, removed 45M10	06-0153
Rev C	12-07-2007	Added 45M20	07-0228
Rev D	06/29/2010	Added 45M20DX	10-0102
Rev E	08/17/2011	New model for 17" monitor, all sections updated, removed 45M20DX	11-0101

2. Warning

TO REDUCE THE RISK OF FIRE OR ELECTRIC SHOCK:
DO NOT EXPOSE THIS PRODUCT TO RAIN OR MOISTURE.
DO NOT INSERT ANY METALLIC OBJECT THROUGH VENTILATION GRILLS.

CAUTION:

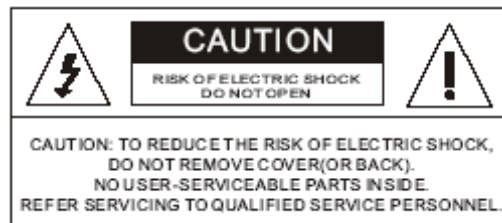

Explanation of Graphical Symbols



The lightning flash with arrowhead symbol, within an equilateral triangle, is intended to alert the user to the presence of non-insulated dangerous voltage within the product's enclosure that may be of sufficient magnitude to constitute a risk of electric shock to persons.



The exclamation point within an equilateral triangle is intended to alert the user to the presence of important operating and maintenance (servicing) instructions in the literature accompanying the product.

3. Precautions

3.1. Safety

Should any liquid or solid object fall into the cabinet, unplug the unit and have it checked by the qualified personnel before operating it any further. Unplug the unit from the wall outlet if it is not going to be used for several days or more. To disconnect the cord, pull it out by the plug. Never pull the cord itself. Allow adequate air circulation to prevent internal heat built-up. Do not place the unit on surfaces (rugs, blankets, etc.) or near materials (curtains, draperies) that may block the ventilation holes.

3.2. Installation

Do not install the unit in an extremely hot or humid place or in a place subject to excessive dust or mechanical vibration. The unit is not designed to be waterproof. Exposure to rain or water may damage the unit.

3.3. Cleaning

Clean the unit with a slightly damp soft cloth. Use a mild household detergent. Never use strong solvents such as thinner or benzene as they might damage the finish of the unit.

Retain the original carton and packing materials for safe transport of this unit in the future.

4. Federal Communications Commission (FCC) Statement

This Equipment has been tested and found to comply with the limits for a Class B digital device, pursuant to Part 15 of the FCC rules. These limits are designed to provide reasonable protection against harmful interference in a residential installation. This equipment generates, uses and can radiate radio frequency energy and, if not installed and used in accordance with the instructions, may cause harmful interference to radio communications. However, there is no guarantee that interference will not occur in a particular installation. If this equipment does cause harmful interference to radio or television reception, which can be determined by turning the equipment off and on, the user is encouraged to try to correct the interference by one or more of the following measures:

- Reorient or relocate the receiving antenna.
- Increase the separation between the equipment and receiver.
- Connect the equipment into an outlet on a circuit different from that to which the receiver is connected.
- Consult the dealer or an experienced radio/TV technician for help.

You are cautioned that changes or modifications not expressly approved by that party responsible for compliance could void your authority to operate the equipment.

This device complies with Part 15 FCC Rules. Operation is subject to the following two conditions:

- (1) This device may not cause harmful interference.
- (2) This device must accept any interference received including interference that may cause undesired performance.

5. Features

5.1. 45M10-1 10.4" TFT

- NTSC/ PAL Auto Selectable
- IR Remote Control Enabled
- Inputs/Outputs: 2 BNC Composite Video, S-Video, 2CH Audio (RCA) & PC IN
- Auto Termination 75 Ohms
- VESA Standard Bracket & Desktop Mount
- Easy OSD Menu User Interface
- Wall Mountable

5.2. 45M15 15" TFT

- NTSC/ PAL Auto Selectable
- 2/4 H Adaptive Comb Filter For Y/C Separation
- IR Remote Control Enabled
- Inputs/Outputs: 2 BNC Composite Video, S-Video, 2CH Audio (RCA) & PC IN
- Auto Termination 75 Ohms
- VESA Standard Bracket & Desktop Mount
- Easy OSD Menu User Interface
- Wall Mountable

5.3. 45M17 17" TFT

- NTSC/ PAL Auto Selectable
- Ultra High Resolution (1280 x 1024 Pixels)
- IR Remote Control Enabled
- Inputs/Outputs: 1 BNC Composite Video, S-Video, 1CH Audio (RCA) & PC IN
- Auto Termination 75 Ohms
- VESA Standard Bracket & Desktop Mount
- Easy OSD Menu User Interface
- Wall Mountable
- 3D Comb Filter
- 3D De-interlace technology
- PIP Control (only in PC/Video Mode)
- Built-in Speakers

5.4. 45M20-1 20" TFT

- NTSC/PAL Auto Selectable
- 450 cd/m2 Brightness
- IR Remote Control Enabled
- Inputs/Outputs: 2 BNC Composite Video, S-Video, 2CH Audio (RCA) & PC IN
- Auto Termination 75 Ohms
- VESA Standard Bracket & Desktop Mount
- Easy OSD Menu User Interface
- Wall Mountable

6. Operating Instructions

6.1. Control for 10", 15" and 20" LCDs

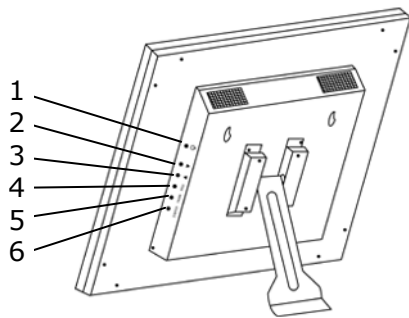

Figure 1. 10.4" LCD Monitor

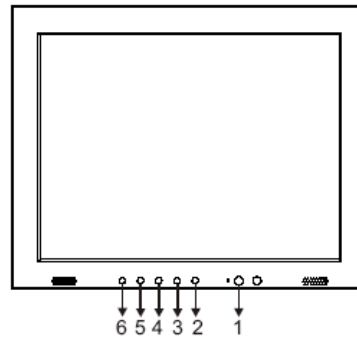



Figure 2. 15", 20" LCD Monitors

- 1. Power**
Monitor power ON / OFF. At OFF mode, monitor will be at standby status
Green Light -- Power On
Red Light -- Standby mode
- 2. Adjust** 
Increase the value on the OSD menu or turn ON / OFF function
- 3. Adjust** 
Decrease the value on the OSD menu or turn ON / OFF function
- 4. Item**
Chose sub menu from Audio / Video / Image
Press again to enter selected option
- 5. Menu**
OSD menu ON / OFF control
- 6. Source**
Select input signal from AV1, AV2, S-Video or PC

Note: Push "menu" and "up" to put into key-lock mode, and push again to unlock.

6.2. Control for 17" LCD

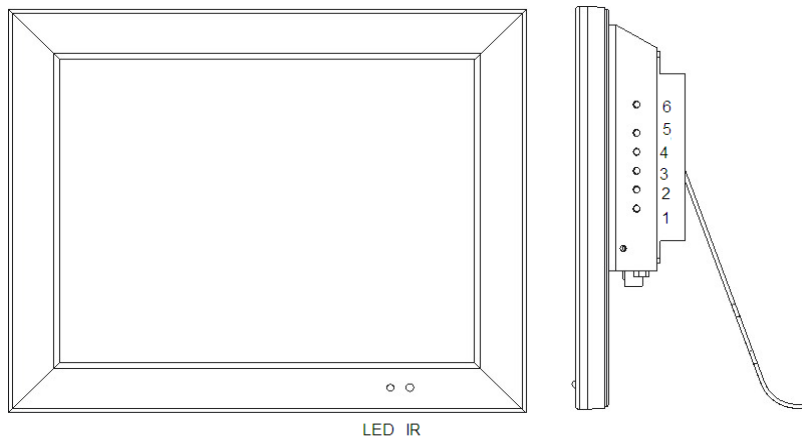



Figure 3. 17" LCD Monitor

- 1. Power**
Monitor power ON / OFF. At OFF mode, monitor will be at standby status
Green Light -- Power On
Red Light -- Standby mode
- 2. Adjust** 
Increase the value on the OSD menu or turn ON / OFF function
- 3. Adjust** 
Decrease the value on the OSD menu or turn ON / OFF function
- 4. Item/Select**
Choose sub menu Hot key selection for Brightness/ Contrast/ Backlight/ Sharpness/ Hue/ Color/ Volume
Press again to enter selected option
- 5. Menu/Function**
OSD menu ON / OFF control
- 6. Source**
SDE: Select input signal from AV1, S-Video or PC.
SHDE: Select input signal from AV1, AV2, S-Video, PC, HD.
Used as "Return/Exit" function in OSD menu

Push "Menu" and "Up" into key-lock mode, and push again into unlock.

7. Connectors

7.1. 10.4" Monitor Back Panel

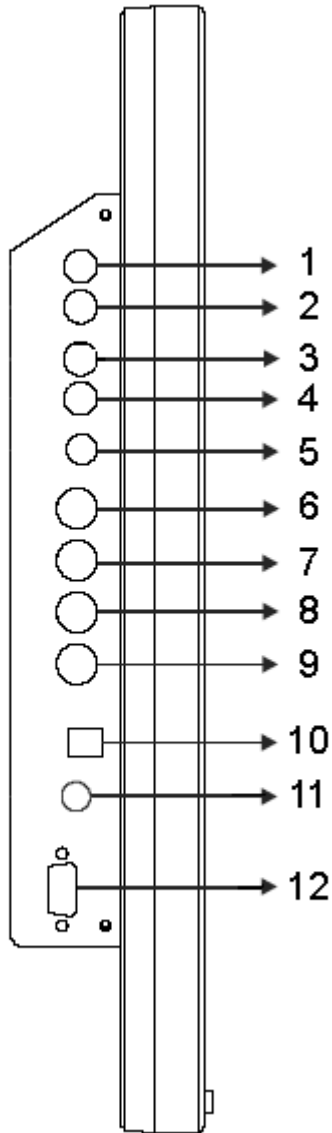

Figure 1. 10.4" Back Panel

- 1 **AUDIO 2 OUT**
Audio looping outputs for AUDIO 2
- 2 **AUDIO 2 IN**
Stereo Audio Signal Input, this input is for PC or Av2 or S-Video (refer to note below)
- 3 **AUDIO 1 OUT**
Audio looping outputs for AUDIO 1
- 4 **AUDIO 1 IN**
Stereo Audio Signal Input, this input is for Av1 (refer to note below)
- 5 **Y/C IN (S-Video)**
Y/C separated signal input
- 6 **VIDEO 2 OUT**
Video looping output for VIDEO 2
- 7 **VIDEO 2 IN**
Composite signal Input for VIDEO 2
- 8 **VIDEO 1 OUT**
Video looping output for VIDEO 1
- 9 **VIDEO 1 IN**
Composite signal Input for VIDEO1
- 10 **Regulated DC12V Power Input**
- 11 **Audio Live Out**
- 12 **PC VGA IN**

Note: Audio out is muted until video is present

Audio Connections

	Audio 1	Audio 2
PC		√
AV1	√	
AV2		√
S-Video		√

7.2. 17" Monitor Back Panel

Connection: SDE Series

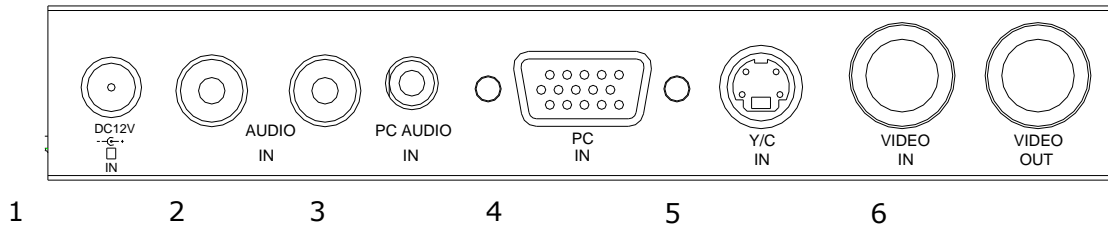

Figure 2. 17" Back Panel

1. Regulated DC12V Power Input
2. AUDIO R/L In
Audio Signal Input, this input is for Video and Y/C
3. PC AUDIO IN
4. PC IN
5. Y/C IN (S-Video)
6. Video IN/OUT

7.3. 15", 20" Monitor Back Panel

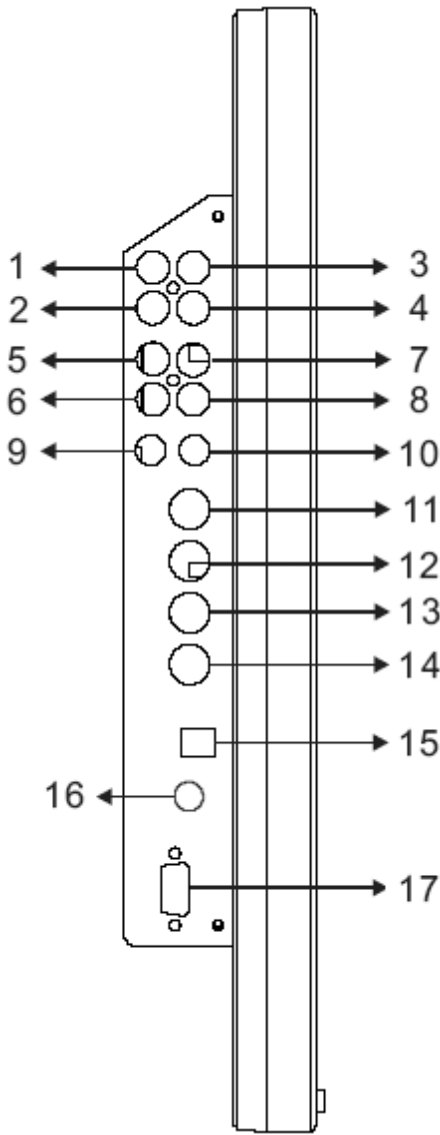

Figure 3. 15", 20" Back Panel

- 2,4 **AUDIO 2 IN (L/R)**
Stereo Audio Signal Input, this input is for PC or Av2 or S-Video (refer to note below)
- 1,3 **AUDIO 2 OUT (L/R)**
Audio looping outputs for AUDIO 2
- 6,8 **AUDIO 1 IN (L/R)**
Stereo Audio Signal Input, this input is for Av1 (refer to note below)
- 5,7 **AUDIO 1 OUT (L/R)**
Audio looping outputs for AUDIO 1
- 9 **Y/C IN (S-Video)**
Y/C separated signal input
- 10 **Y/C OUT (S-Video)**
Y/C separated signal looping output
- 11 **VIDEO 2 OUT**
Video looping output for VIDEO 2
- 12 **VIDEO 2 IN**
Composite signal Input for VIDEO 2
- 13 **VIDEO 1 OUT**
Video looping output for VIDEO 1
- 14 **VIDEO 1 IN**
Composite signal Input for VIDEO1
- 15 **Regulated DC12V Power Input (500mA)**
- 16 **External Speakers Out**
Stereo L/R, 2w x 2w/8 ohms
Mutes internal speakers
- 17 **PC VGA IN**

Note: Audio out is muted until video is present

Audio Connections

	Audio 1	Audio 2
PC		√
AV1	√	
AV2		√
S-Video	√	

8. OSD Architecture

8.1. Video Function 10", 15", 20"

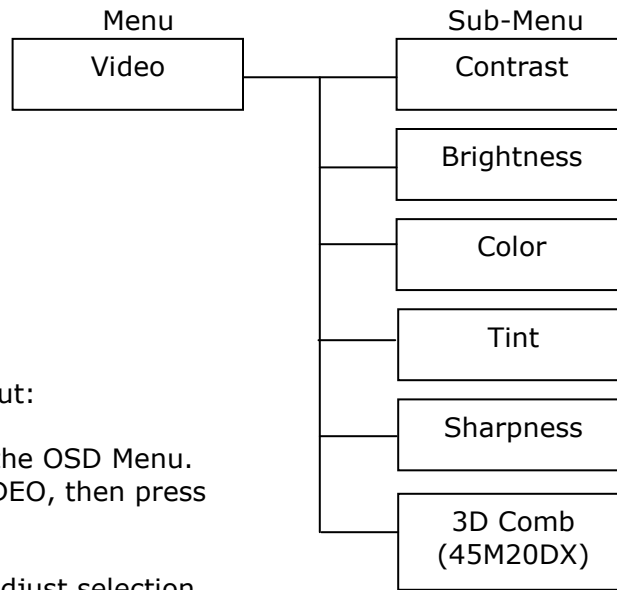

Press **SOURCE** to select a video input:

Press the MENU button to bring up the OSD Menu.
Press ◀ ▶ again to select VIDEO, then press ITEM twice to enter submenu.

As shown, press ◀ ▶ keys to adjust selection.



Figure 4. Example

Note: In remote control, press   key to adjust.
(After adjustment, the monitor will store new settings)

Contrast

Permits adjustment for contrast between light or dark areas of the picture.

Brightness

Adjusts the overall picture shade and brightness. Tip: Use the Brightness to make details in the dark areas of the picture to be just visible, and Contrast to brighten the picture without causing video noise and foreheads to turn white.

Color

Adds color to the black and white picture content (of a color signal), and is usually set for viewer's preference in color saturation.

TINT

Adjusts the colors on the screen. Reds and yellows are most noticeable. Tint also sets for pleasing facial tones. **Note: Appears in NTSC mode only.**



Sharpness

Sets the desired sharpening enhancement to the picture.

8.2. Video Function (PC Mode Only) 10", 15", 20"

Press **SOURCE** to select a image input:

Press the MENU button to bring up the OSD Menu.

Press   again to select IMAGE, then press ITEM twice to enter submenu.

As shown, press   keys to adjust selection.

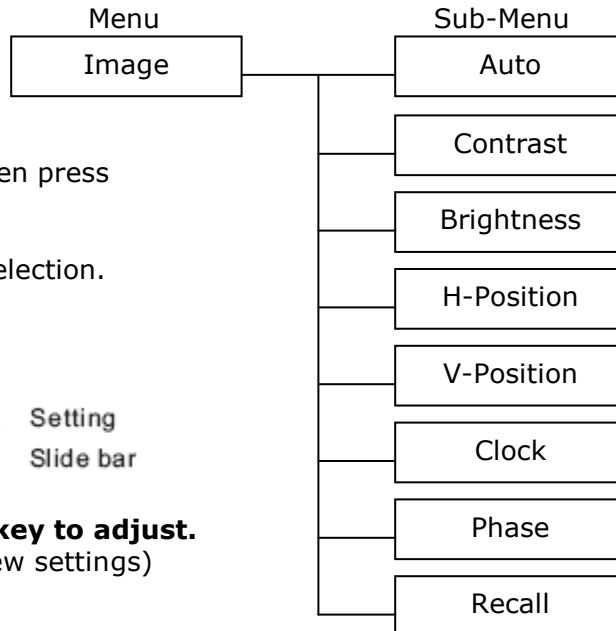
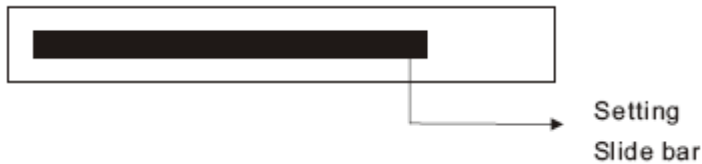

Note: In remote control, press   key to adjust.
(After adjustment, the monitor will store new settings)

Auto

Auto detect screen detail data, such as clock and phase.

Contrast

Permits adjustment for contrast between light and dark areas of the picture.

Brightness

Adjusts the overall picture shade and brightness.

Tip: Use the Brightness to make details in the dark areas of the picture to be just visible, and Contrast to brighten the picture without causing video noise and foreheads to turn white.

H-Position

Allows adjustment for the horizontal position.

V-Position

Allows adjustment for the vertical position.

Clock

Is used to adjust to the best picture quality. It adjusts the number of the clock pixels across one timeline. Therefore it can affect the picture's position and size.

Note: Improper adjustment will caused image failure.

Phase

Is used to adjust to the best picture quality. It adjusts the sampling phase across one pixel at a time. When the phase is not adjusted properly, the picture will be unclear. Therefore this value should be carefully adjusted.

Note: Improper adjustment will caused image failure.

Recall

Sets the monitor to the original factory setting.

8.3. OSD Functions for 17" (45M17)

8.3.1. Source

Push <**Source**>button to selection the channel.

SDE series: AV/SVIDEO/PC

SHDE series: AV1/AV2/SVIDEO/PC/HD

8.3.2. Item (Hot key, simple operation)

Use < **Item** > button as hot key to call out Adjust bar. Then use +/- button to increase/decrease the menu bar. (Brightness/Contrast/Backlight/Sharpness/Hue/Color /Volume)



8.3.3. OSD Menu

Push <**Menu**>button to display the **Main menu**.

Main menu includes (Picture), (Sound), (PIP), (Display), (Function) and (Exit) 6 categories.

Use **Select** (▲▼) button to select the function category to be adjusted.

Push the **Menu/OK** button to enter the selected category.

8.3.3.1. PICTURE

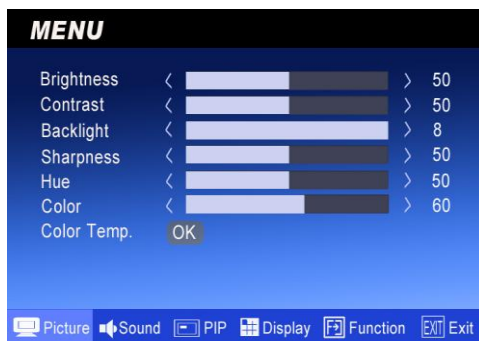

(Mode: AV, S-VIDEO, HD)

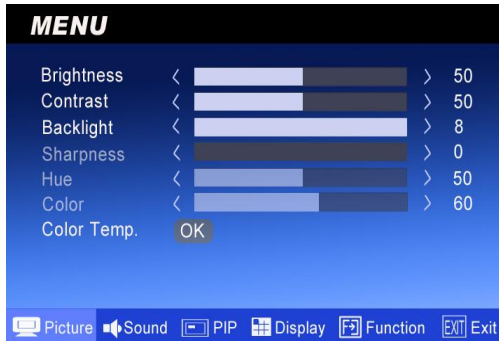

(Mode: PC D-Sub)

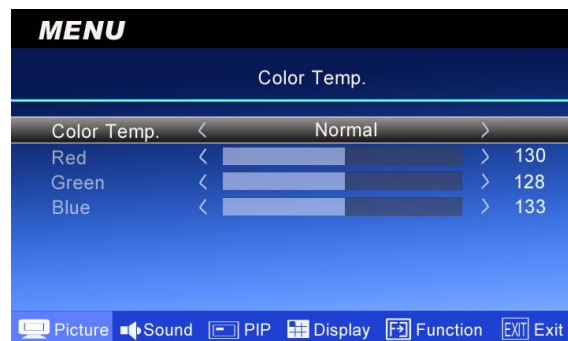

(Color Temp.)

Use Select (▲▼) button to select the item to be adjusted.

Push <Menu> to confirm the selected item;

Use Select (▲▼) button to adjust and then push <Source> button to return.

MENU	FUNCTION	MODE
Brightness	Use Select (▲▼) button to increase/decrease the screen brightness.	all
Contrast	Use Select (▲▼) button to increase/decrease the screen contrast.	all
Back light	Use Select (▲▼) button to increase/decrease the screen backlight.	all
Sharpness	Use Select (▲▼) button to adjust the sharpness of the image.	AV/S-video/HD
Hue	Use Select (▲▼) button to adjust the hue of the image.	AV/S-video/HD
Color	Use Select (▲▼) button to increase/decrease the image color saturation.	AV/S-video/HD
Color Temp	Use Select (▲▼) button to select the desired color temperature. There are Normal / Warmer / Warm / Cool / Cooler / User 6 modes. In User mode, push <MENU> button to enter and adjust the Red/Green/Blue color separately.	all

8.3.3.2. SOUND

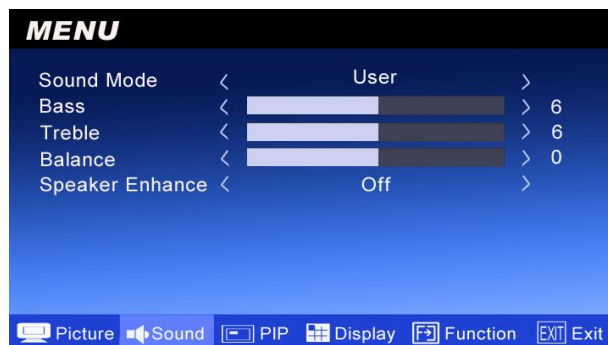

Use **Select** (▲▼) button to select the item to be adjusted. Push **Menu** to confirm the selected item, use **Select** (▲▼) button to adjust and then push <**Source**> button to return.

MENU	FUNCTION	MODE
Sound Mode	Use Select (▲) (▼) button to select Theater//Music/News/Original/User 5 kinds of modes	all
Bass	Use Select (▲) (▼) button to adjust the Bass	all
Treble	Use Select (▲) (▼) button to adjust the Treble	all
Balance	Use Select (▲) (▼) button to adjust the left / right balance	all
Speaker Enhance	Use Select (▲) (▼) button to select On/Off	all

8.3.3.3. PIP

Use **Select** (▲▼) button to select the item to be adjusted. Push **Menu** to confirm the selected item, use **Select** (▲▼) button to adjust and then push <**Source**> button to return.

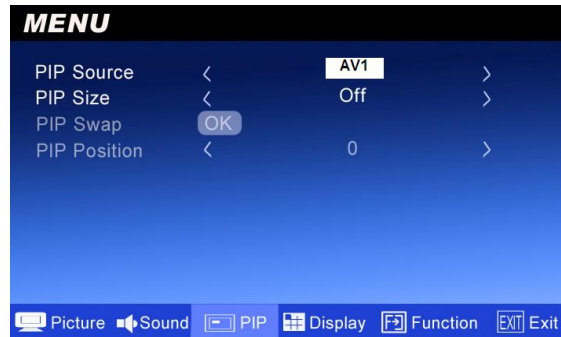

MENU	FUNCTION
PIP Source	Use Select (▲▼) button to select the source of sub-picture.
PIP Size	Use Select (▲▼) button to select the size of sub-picture Small/Medium/Large/1+1/Off. Off means PIP function is turned off.
PIP Swap	Push <MENU> button to switch the main picture and sub-picture. (This function works only when sub-picture exists)
PIP Position	Use Select (▲▼) button to select the position of sub-picture(0~5) 4 corners and center.(This function works only when sub-picture exists)

8.3.3.4. Display

Use Select (▲▼) button to select the item to be adjusted. Push Menu to confirm the selected item , use Select (▲▼) button to adjust and then push <Source> button to return.

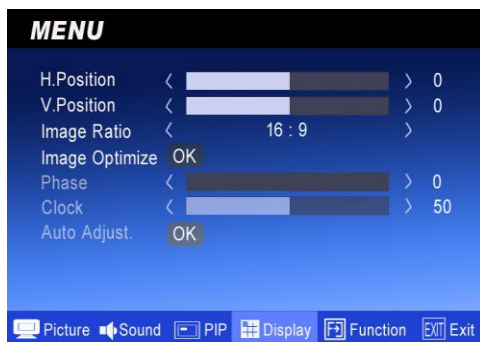

(Mode: AV, S-VIDEO, HD)

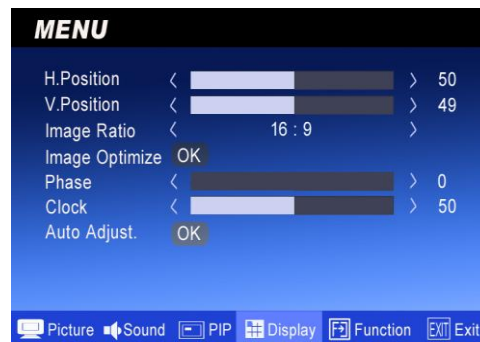

(Mode: PC D-Sub)

MENU	FUNCTION	MODE
H. Position	Use Select (▲▼) button to adjust the horizontal position of the image.	all
V. Position	Use Select (▲▼) button to adjust the vertical position of the image.	all
Image Ratio	Use Select (▲▼) button to select the image ratio. PC mode : 4:3/16:9 AV/S-VIDEO mode : 4:3/16:9/14:9/Movie/Panorama	all
Image Optimize	Push <MENU> button to enter the sub-menu and use Select (▲▼) button to adjust/select	all
Phase	Use Select (▲▼) button to increase/decrease the noise on the screen.	PC
Clock	Use Select (▲▼) button to increase/decrease the snowflake noise on the screen.	PC
Auto Adjust	Push <MENU> button to adjust the best image.	PC

Image Optimize

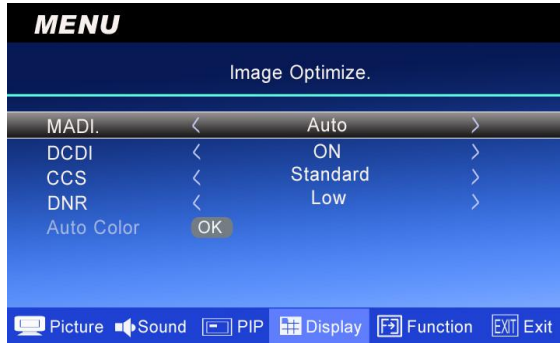

(Mode: AV, S-VIDEO, HD)

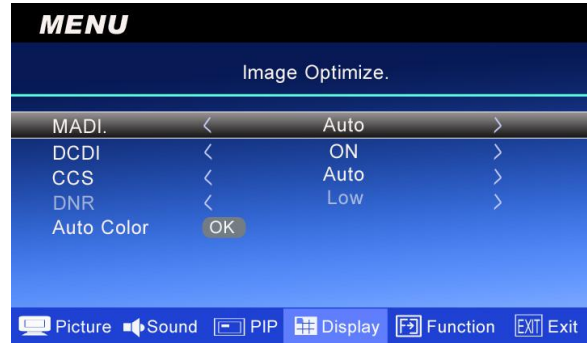

(Mode: PC D-Sub)

MENU	FUNCTION	MODE
MADI	Use Select (▲▼) button to select Auto/Off/Standard 3 kinds of modes.	all
DCDI	Use Select (▲▼) button to select On/Off.	all
CCS	Use Select (▲▼) button to select Auto/Off/Standard 3 kinds of modes.	all
DNR	Use Select (▲▼) button to select Low/ Medium/ High/ Off 4 kinds of modes.	AV/S-video/HD
Auto Color	Push <MENU> button to adjust the best image color.	PC

8.3.3.5. Function

Use Select (▲▼) button to select the item to be adjusted. Push MENU to confirm the selected item, Use Select (▲▼) button to adjust and then push <Source> button to return.

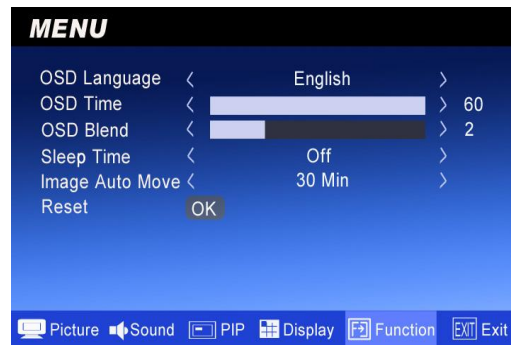

MENU	FUNCTION	MODE
OSD Language	Use Select (▲▼) button to select the desired language.	all
OSD Time	Use Select (▲▼) button to increase/decrease the OSD display time.	all
OSD Blend	Use Select (▲▼) button to increase/decrease the transparent degree of the OSD display.	all
Sleep Time	Use Select (▲▼) button to select the automatic turn off time. Off/10/20/30/60/90/120/150/180 Min.	all
Image Auto Move	Use Select (▲▼) button to select the image move time. Off/30/60/90/120/180 Min.	all
Reset	Push <MENU> button to return to factory default setting.	all

8.3.3.6. Exit

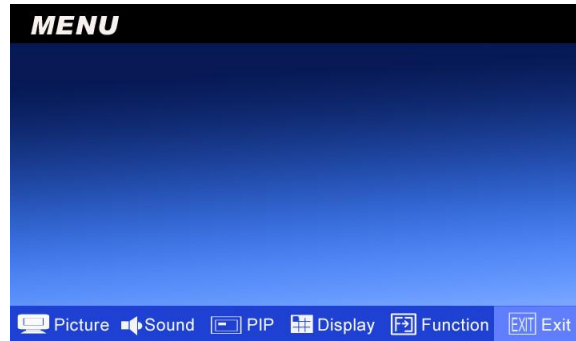

Push <**MENU**> to exit the OSD menu.

8.4. Audio Function (10", 15" 20")

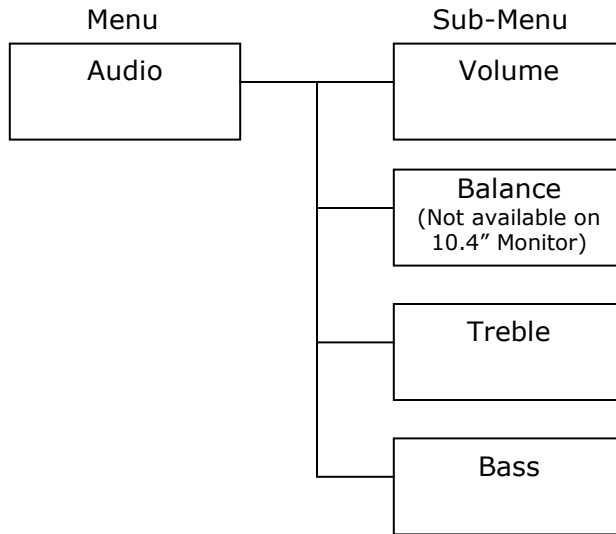

Press the MENU button to bring up the OSD Menu.

Press again to select AUDIO, then press ITEM twice to enter submenu.

As shown, press keys to adjust selection.



Figure 5. Example

Note: In remote control, press key to adjust.
(After adjustment, the monitor will store new settings)

Volume

Controls built-in as well as external speakers output volume.

Note: Volume control can also be adjusted by hot key. (Remote Operation)

Balance (Not available on 10.4" Monitor)

Controls built-in speakers output volume.

Treble

Audio treble adjustment.

Bass

Audio bass adjustment. Will not affect internal speakers. Bass adjustment is dependant on external speaker response.

Note: Audio is muted without accompanying video input.

9. LCD Monitor Mounting Guide

9.1. Desktop Mount

Adjust the viewing angle of LCD to fit the most comfortable monitoring status.

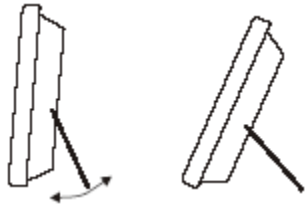

Figure 6.

9.2. Wall / VESA mount

Please follow the fix-hole size on back panel to install the LCD to the wall directly, or use a VESA mount.

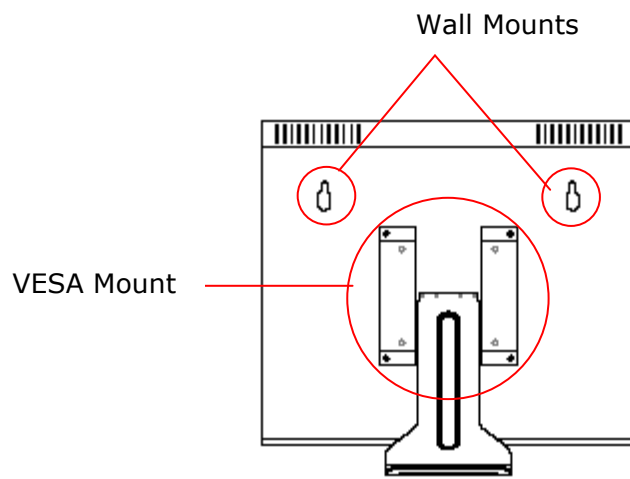

Figure 7.

10. Device Connectors

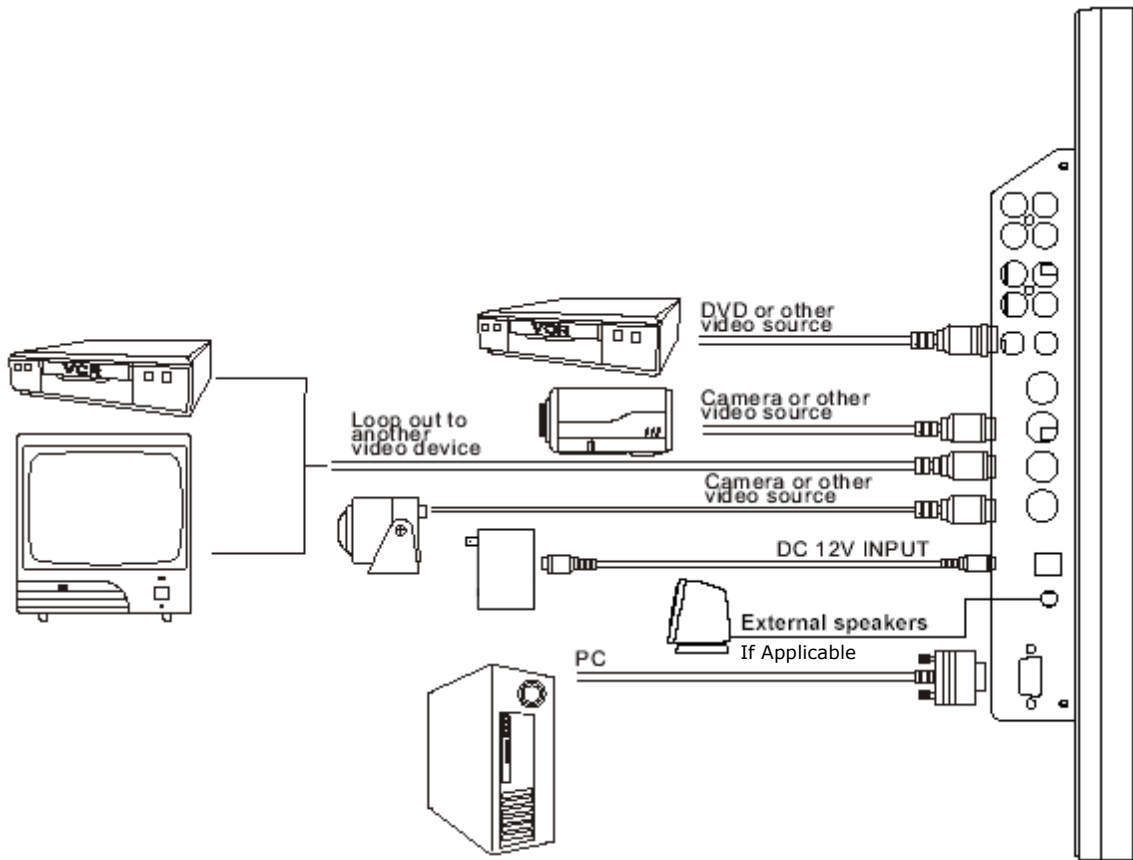

Figure 8. LCD Connectors

- Connect PC to Monitor through VGA connector as shown in the above picture
See Table 1 for support resolutions.
- Connect External device such as DVD or Game Player to Monitor as shown in the above picture
- Connect CCD Camera 1 and 2 to Monitor through Video Input 1 and 2 (BNC Connect) as showing in the above picture

Note: Please refer to Specification for auto detection after changing resolution setting.

Table 1. Support Resolutions

10.4" Monitor

640 x 480 60Hz		1024 x 768 60Hz
640 x 480 72Hz		1024 x 768 70Hz
640 x 480 75Hz		1024 x 768 75Hz

15" Monitor

640 x 480 60Hz	800 x 600 56Hz	1024 x 768 60Hz
640 x 480 72Hz	800 x 600 70Hz	1024 x 768 70Hz
640 x 480 75Hz	800 x 600 72Hz	1024 x 768 75Hz
	800 x 600 75Hz	

17" Monitor

640 x 480 60Hz	800 x 600 56Hz	1024 x 768 60Hz
640 x 480 72Hz	800 x 600 70Hz	1024 x 768 70Hz
640 x 480 75Hz	800 x 600 72Hz	1024 x 768 75Hz
	800 x 600 75Hz	1280 x 1024 60Hz

20" Monitor(s)

640 x 480 60Hz	800 x 600 56Hz	
640 x 480 72Hz	800 x 600 70Hz	
640 x 480 75Hz	800 x 600 72Hz	
	800 x 600 75Hz	

11. Specifications

Electrical

	45M10-1	45M15	45M17	45M20-1
Operating system	NTSC / PAL / SVGA / VGA / XGA	NTSC / PAL / XGA / VGA / SVGA	NTSC / PAL / XGA / VGA / SXGA@60Hz / SVGA	NTSC / PAL / VGA / SVGA
Aspect ratio	4:3			
Picture diagonal	10.4"	15"	17.25"	20"
Active area (W x H)	8.3" x 6.2" (211.2mmx158.4mm)	12" x 9" (304.1mm x 228.1mm)	13.3" x 10.6" (338mm x 270mm)	18.9" x 12.04" (480mm x 306mm)
Resolution (H x V)	1024 x 768	1024 x 768	1280 x 1024	800 x 600
Response time	25ms	16ms	12ms	16ms
Video angle	Up / Down 140 ⁰ , Left / Right 120 ⁰	Up / Down 135 ⁰ , Left / Right 160 ⁰	Up / Down 160 ⁰ , Left / Right 170 ⁰	Up / Down 140 ⁰ , Left / Right 160 ⁰
Brightness	300cd/m ²	250 cd/m ²	300 cd/m ²	450 cd/m ²
Contrast Ratio	500:1	500:1	800:1	500:1
Display colors	262K	26M	16.7M	16.7M
Video input/output signal	Video: 2 CH Composite video 1Vp-p 75ohm (45M17) 1 CH Composite video 1Vp-p 75ohm S-Video: Y=1.0Vp-p w/neg. sync C=0.285Vp-p PC: Analog RGB			
In/out impedance	75 ohms / auto termination			
Audio input/output	2CH L/R, 50~100mVp-p (45M17) 1CH L/R, 50~100mVp-p			
Power source	90~260V AC 60Hz / 50Hz adapter / 12V DC			
Power consumption	1.1A / 15W	1.5A / 18W	2.5A / 30W	3.5A / 42W

Environmental

Ambient operating temperature	-10° C ~ 50° C (14°F ~ 122°F)			
Operating Humidity	10% - 85%	20% - 80%		

Mechanical

Dimensions W x H x D	10.48" x 8.4" x 2.26" 266.2mm x 213.3mm x 57.4mm	12.2" x 15.2" x 3.2" 310mm x 385mm x 80mm	13.9" x 16.5" x 3.15" 353mm x 419mm x 80mm	19.33" x 15.75" x 3.15" 491mm x 400mm x 80mm
Weight	2.2 Kg (4.85 lbs)	5.5 kg (12.1 lbs)	5.5 kg (12.12 lbs)	7 kg (15.43 lbs)
Accessories <i>included</i>	Power supply Power cord 15 pin D-sub Remote control Bracket: VESA 100 standard	Power supply Power cord 15 pin D-sub Audio cable Bracket: VESA 100 standard	Power supply Power cord 15 pin D-sub Audio cable Remote control Bracket: VESA 100 standard	Power supply Power cord 15 pin D-sub Audio cable Bracket: VESA 100 standard
Connectors	Video: 2CH BNC input / output (45M17) 1CH BNC input / output Audio: 2CH RCA R. L. input / output (45M17) 1CH RCA R. L. input / output PC: 15-pin D-sub connector S-Video: 4-pin min-din			
Safety standards	FCC, CE, UL			

12. Appendixes

12.1. Troubleshooting

Problem:

1. No power

2. No video or audio

3. Bad video or audio

4. Image not stable

5. Abnormal line

6. Ghost image

7. Desired video disappears

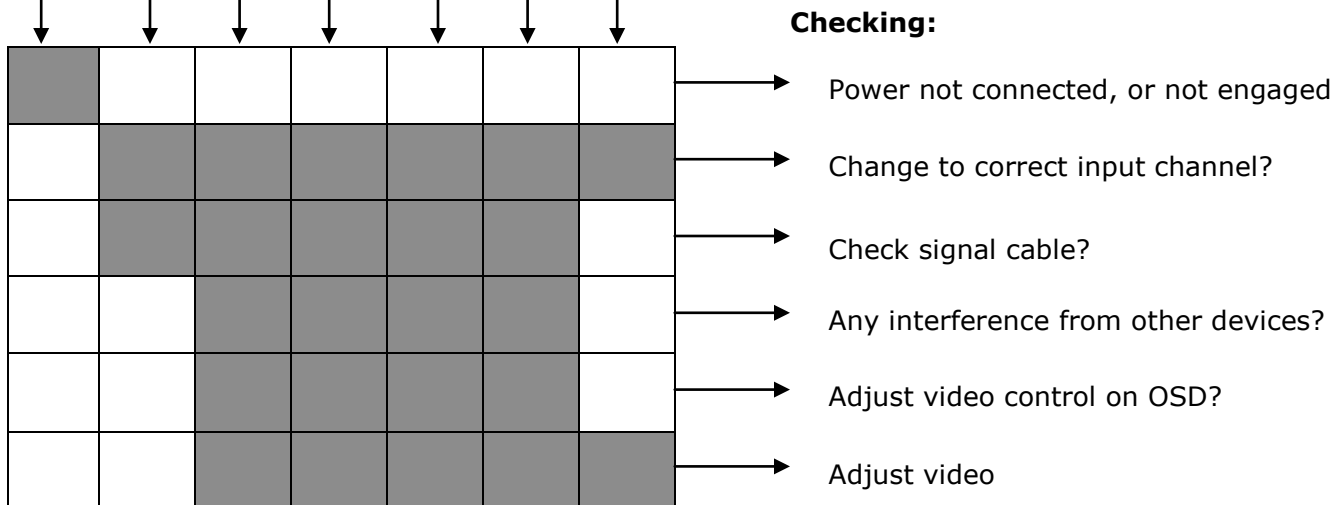

Checking:

12.2. Package Contents

- A. LCD monitor
- B. Power cord
- C. Accessory kit
 - a. DB15 – DB15 VGA cable
 - b. 1/8" male to 1/8" male mini stereo plug cable
- D. User manual
- E. 12V Power Adapter
- F. Remote Control

13.Remote Control

13.1. Remote Control For 10", 15", 20" LCDs

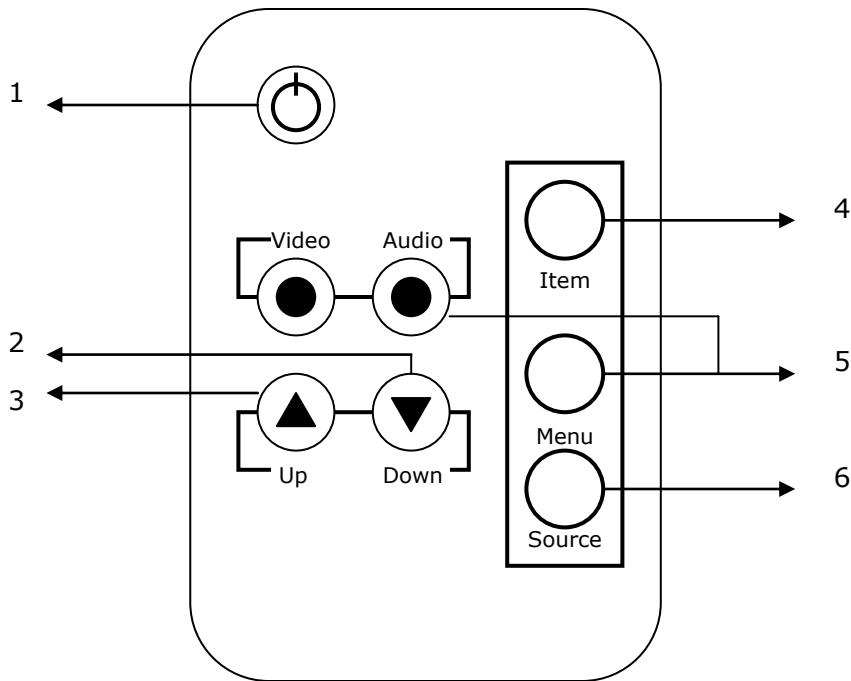

1. **Power**
Monitor power ON / OFF. At OFF mode, monitor will be on standby status
LED - Green Light -- Power On
Red Light -- Standby mode
2. **Adjust ▼**
Decrease the value on the OSD menu or turn ON / OFF function
3. **Adjust ▲**
Increase the value on the OSD menu or turn ON / OFF function
4. **Item**
Chose sub menu from Audio / Video / Image
Press again to enter selected option
5. **Menu**
OSD menu ON / OFF control
6. **Source**
Select input signal from AV1, AV2, S-Video or PC

13.2. Remote Control for 17" LCD

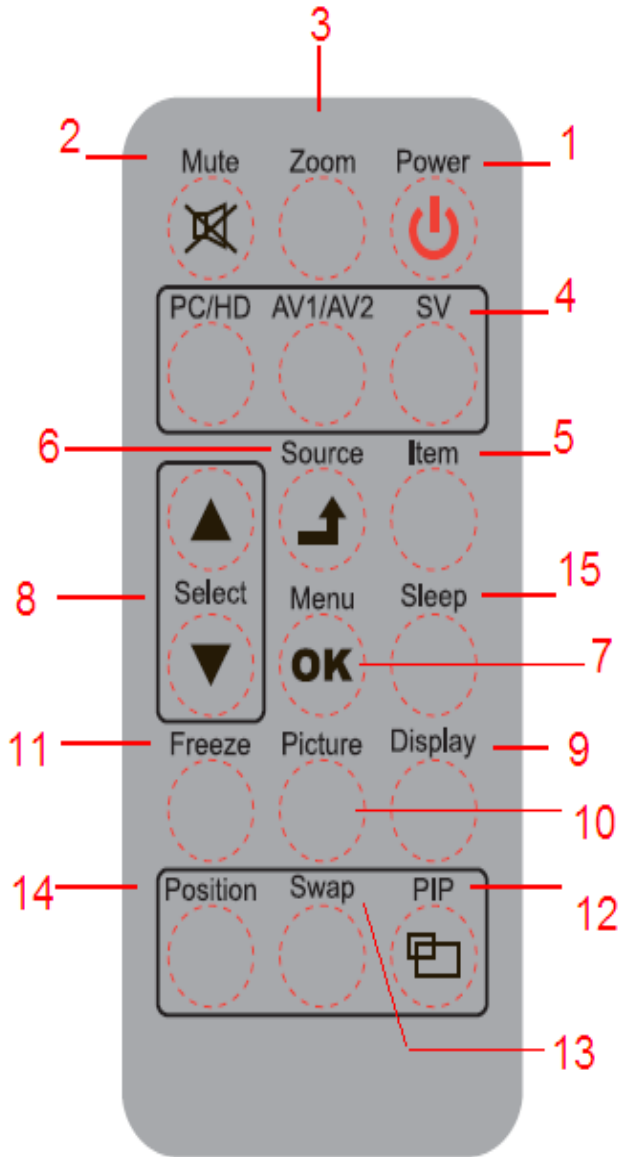

1. **Power:** Push to turn on and turn off the unit.
2. **Mute:** Disable the unit's sound output, press the button again or the Volume +/- button to restore the volume.
3. **Zoom:** Toggle between the image ratios. (4:3/16:9/14:9/Movie/Panorama)
4. **PC/HD, AV1/AV2, SV:** Press to choose the desired signal source directly.
5. **Item:** As hot key selection for Brightness/Contrast/Backlight/Sharpness/Hue/Color /Volume > adjust
6. **Source/(Exit):** Push to select input signal. Used as "Return/Exit" function in OSD menu.
7. **OK/Menu:** Push to call out OSD menu. Used as "Confirm / OK" function in OSD menu.
8. **Select▲/▼:** Change the function up or down.
9. **Display:** Press to display the information on the screen, such as resolution, signal source.
10. **Picture:** Toggle between the different picture modes. Standard /Soft/Personal /Bright.
11. **Freeze:** Press to freeze the picture (AV1, AV2, SVideo), press again to restore.

12. **PIP:** Press to activate the PIP function and select the size of sub-picture Small/Medium/Large/1+1/Off. Off means PIP function is turned off.
13. **Swap:** In the PIP mode, press the button to switch the main picture and sub-picture. (This function works only when sub-picture exists.)
14. **Position:** PIP mode Press to select the position of sub-picture. (4 corners and center)
15. **Sleep:** Select the Automatic turn off time.

14.Contact Information

For technical assistance with this product, please contact the supplier from whom the product was purchased.

For OEM inquiries, contact Videology Imaging Solutions:

North / South America:	Europe:
Videology Imaging Solutions Inc. 37M Lark Industrial Parkway Greenville, RI 02828 USA Tel: (401) 949-5332 Fax: (401) 949-5276	Videology Imaging Solutions Europe Neutronenlaan 4 NL-5405 NH Uden, Netherlands Tel: +31 (0) 413 256 261 Fax: +31 (0) 413 251 712

Please visit our website at: <http://www.videologyinc.com>

VIDEOLOGY IMAGING SOLUTIONS is an ISO 9001 registered video camera developer and manufacturer serving industrial, machine vision, biometric, security, and specialty OEM markets. Videology designs, develops, manufactures, and distributes video, image acquisition, and display technologies and products to OEMs worldwide.